





PULSE

SMART system controller

A home hub that combines the individual devices of the Auraton Smart into one system and enables you to control them via the Auraton Smart App.

Auraton Pulse allows you to transfer information between Auraton Smart devices and your phone or tablet. All you need is the Auraton Smart App to manage your entire home anytime, anywhere.

-  Internet connection via Ethernet cable
-  Over the air - the device updates from the application level on the phone
-  Informative RGB diode – you can change its colour and intensity via the app
-  two-way communication enabling both sending and receiving information (from other elements Auraton Smart set)
-  Remembers the functions recently set by the application, which allows them to operate even when the internet connection is unavailable

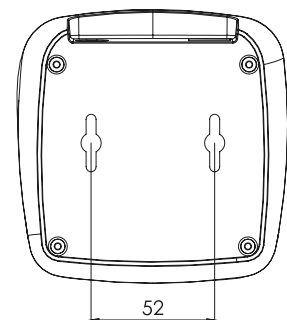
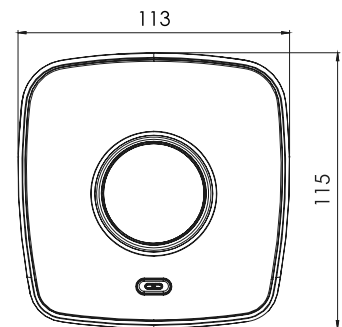
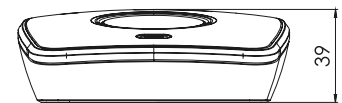

| | |
|-----------------------------|---|
| Operating temperature range | 0 – 45°C |
| Control signals | LED RGB |
| Power supply | Micro USB 5V DC, 3W |
| Radio frequency | 868,300 MHz 868,150 MHz 868,450 MHz 869,800 MHz 433,950 MHz |
| Radio signal strength | 11 dBm |
| Radio receiver category | 2 |
| Operating range | in a typical building, with a standard wall structure - up to 30 m; in open area - up to 300 m |

FOR SMARTER LIVING



Producer:
LARS, Swierkowa 14 St., 64-320 Niepruszewo, PL
tel. +48 61 840 40 40, e-mail: trade@auraton.pl
www.auraton.pl www.auratonsmart.com

