

FLOOD SENSOR

Water leak detector

The Flood Sensor detects water leaks in your home and sends the information to the Flood Sensor Valve, which can shut off the water supply, protecting your home.

Its battery can work up to 10 years without the need to change and thanks to its small dimensions and durable construction, you can easily place the Flood Sensor under a cupboard, washing machine or dishwasher - any place that needs protection.

Thanks to the Auraton Smart mobile application and Flood Sensor you can always check the status of your home and make sure it's safe.





 Over The Air
the device updates from the application level on the phone

 Waterproof
IP 67

 battery life up to 10 years

 two-way communication

 backup communication with the Flood Sensor Valve

 modulation of the radio signal, allowing double the range of communication between the Flood Sensor and Flood Sensor Valve

 withstands pressure up to 100kg



Operating temperature range	-20°C – 45°C
IP code	IP67
Humidity	≤85% no condensation
Control signals	LED, sound signal
Power supply	CR2450 3V (10 year battery)
Internet gateway	Auraton Pulse
Radio frequency	865,500 MHz 867,200 MHz 868,150 MHz 868,450 MHz 869,800 MHz
Radio signal strength	11 dBm
Radio receiver category	2
Operating range	in a typical building, with a standard wall structure - up to 50 m; in open area - up to 150 m

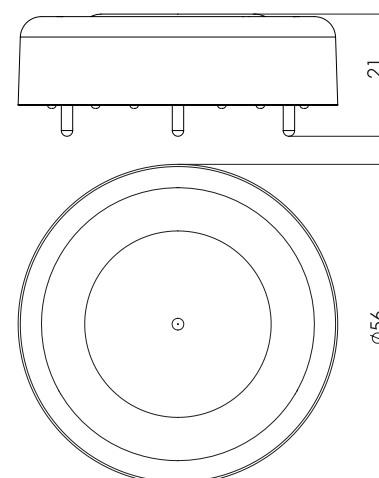

FOR SMARTER LIVING



Producer:
LARS, Swierkowa 14 St., 64-320 Niepruszewo, PL
tel. +48 61 840 40 40, e-mail: trade@auraton.pl
www.auraton.pl www.auratonsmart.com

